

Catálogo de Gráficos y Plumillas.



Rosario
& Cía

GRÁFICOS Y PLUMILLAS PARA
INSTRUMENTOS REGISTRADORES

Calle la Pedrero, C.C. Cem II, Local/Galpón #6,
Terraza de Castillito, San Diego, Edo. Carabobo
Z.P. 2006 Venezuela
SAP: 100019396 Py-MI - PEPS
RIF: J-30082281-8

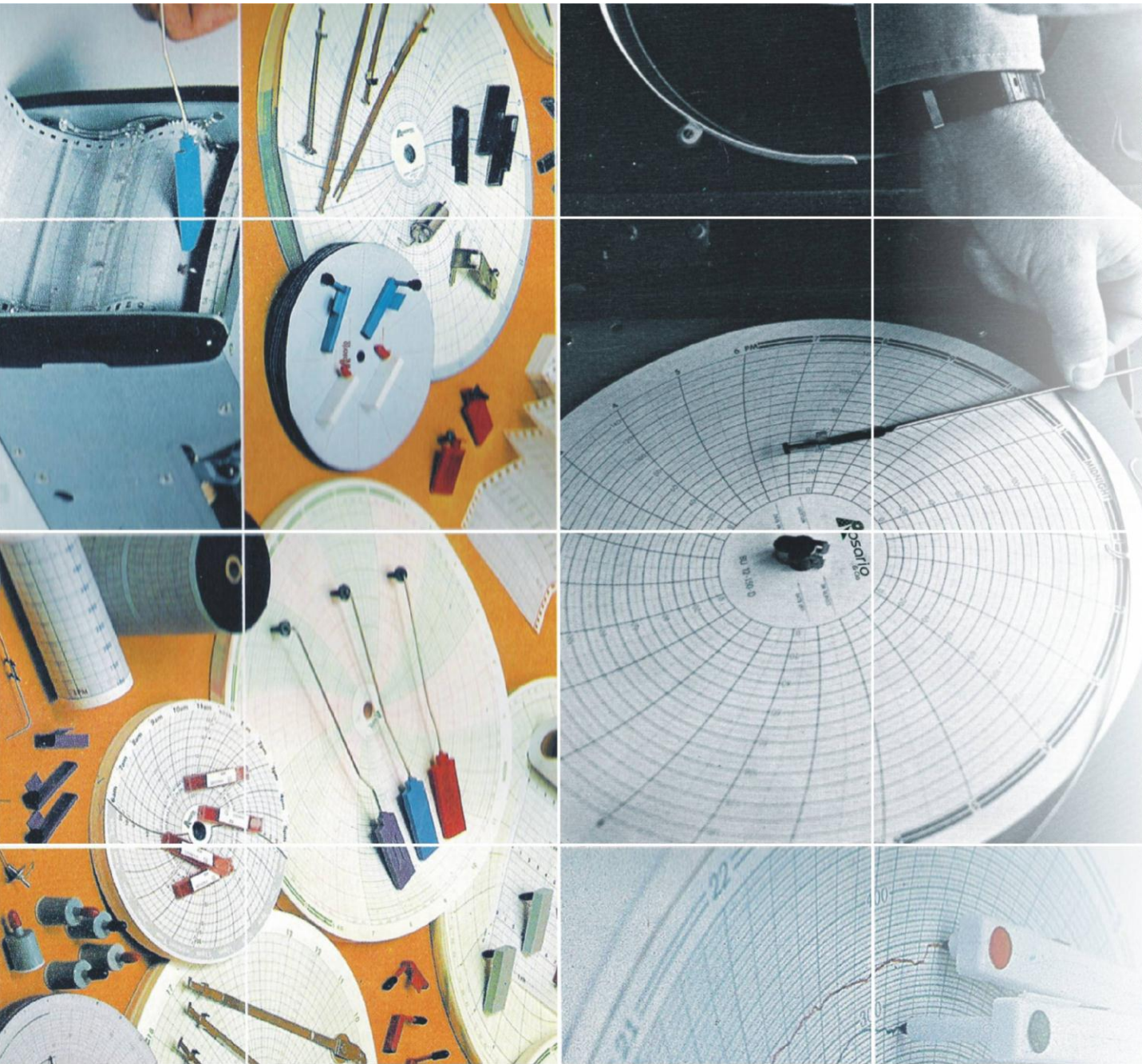

ROSARIO Y CIA, C.A., fabrica PyME, Venezolana, dedicada a la elaboración y comercialización de las **Plumillas Universales** y el **papel especial para Registradores en forma circular y rectangular** para registradores Industriales que utiliza en general las Industrias Manufacturera, Petroleras, Petroquímicas, Químicas, Siderúrgicas, Alimenticias, Textiles, Caucheras, entre otras. Este papel especial para registradores es un bien intermedio y principal aliado de la calidad. Cumpliendo con todas las especificaciones de la norma **ISO 9000**.

La empresa en cuestión, esta insertada en la Industria de las Artes Gráficas también conocida como Industria Litográfica y Tipográfica, siendo este sector de gran importancia en el aparato productivo nacional.



Índice

Pág.

Modelo del Instrumento:

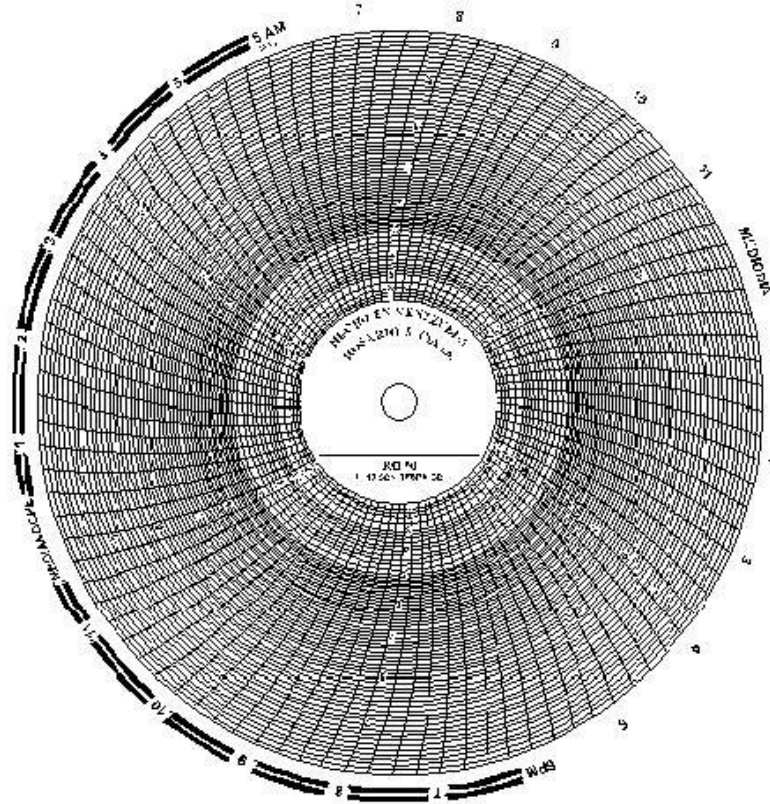

- ABB Instrumentation
- American Meter
- Bailey Controls
- Barton
- Bristol
- Dickson
- Foxboro
- Honeywell
- Masoneilan
- Rockwell
- Weksler

Plumillas Universal Serie 39

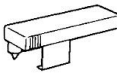

4
5
6
6
7
8
8,9
9,10
10
11
11,12
13

Modelo del Instrumento: ABB Instrumentation

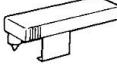
Grafico				Marcadores y Plumillas			
Forma	Nombre	Tamaño	N ^{ro} de partes	Tipo	N ^{ro} de partes	Color	N ^{ro} de partes
	FULSCOPE ER/C	10 -1/2"	TA 500P1225-1		500S1150-1	Roja	82-39-0202-06
					500S1150-3	Azul	82-39-0103-06
					500S1150-2	Verde	82-39-0304-06
	12" FULSCOPE 25,76,78,120,124	11 -1/4"	TA OP3502		155S175-3	#1 Rojo	82-39-0202-06
					155S175-4	#1 Azul	82-39-0203-06
					155S175-5	#2 Rojo	82-39-0302-06
					155S175-6	#2 Azul	82-39-0303-06
					155S175-7	#3 Púrpura	82-39-0406-06

Modelo del Instrumento: American Meter

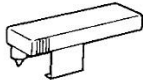
Grafico				Marcadores y Plumillas			
Forma	Nombre	Tamaño	N ^{ro} de partes	Tipo	N ^{ro} de partes	Color	N ^{ro} de partes
	VPT, DRL-FO. Para todos los registradores de presión y temperatura de 8" y 9".	8"	MC P-100		Plumillas Series 39 Universal	Negra	82-39-0101-06
						Roja	82-39-0202-06
						Azul	82-39-0303-06
						Verde	82-39-0404-06
						Púrpura	82-39-0406-06

Cel y WhatApp : 0424-4734343 / Cel0412-2487166 Email: rosariograficos@gmail.com
 Pag Web : <https://www.rosariograficos.com.ve/catalagorosario.pdf>





Modelo del Instrumento: Bailey Controls

Grafico				Marcadores y Plumillas			
Forma	Nombre	Tamaño	N ^{ro} de partes	Tipo	N ^{ro} de partes	Color	N ^{ro} de partes
	Para todos los modelos C, D, K, L, W, WS.	11 -1/4"	Todos los registradores			Rojo	82-39-0102-06
						Azul	82-39-0303-06
						Verde	82-39-0204-06
						Púrpura	82-39-0406-06

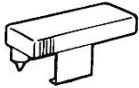

Modelo del Instrumento: Barton

Grafico				Marcadores y Plumillas			
Forma	Nombre	Tamaño	N ^{ro} de partes	Tipo	N ^{ro} de partes	Color	N ^{ro} de partes
	Para todos los modelos.	11 -1/4"	Todos los registradores			Rojo	82-39-0102-06
						Azul	82-39-0303-06
						Verde	82-39-0204-06
						Púrpura	82-39-0406-06

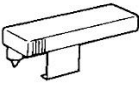
Modelo del Instrumento: Bristol

Grafico		Marcadores y Plumillas					
Forma	Nombre	Tamaño	Nº de partes	Tipo	Nº de partes	Color	Nº de partes
	T169, 44, 530, 531, 532, 541, 616, 626, 765, 4069T, 4069TH, 4631.	4-15/16" hasta 8"	Llamar para verificar tamaño		375985-01-08	Roja	82-22-0102-06
					375985-05-0	Azul	82-22-0103-06
					375985-04-2	Roja	82-22-0202-06
					375985-02-6	Azul	82-22-0203-06
					375985-06-9	Azul	82-22-0303-06
					375985-03-4	Verde	82-22-0304-06
	500, 501, 565, 575, 576, 595, 596 y 4300	11 -1/4"	BR 50003		375985-21-2	Roja	82-39-0102-06
					375985-25-5	Azul	82-39-0103-06
					375985-24-7	Roja	82-39-0202-06
					375985-22-0	Azul	82-39-0203-06
					375985-26-3	Roja	82-39-0303-06
					375985-23-9	Azul	82-39-0304-06



Modelo del Instrumento: Dickson

Grafico				Marcadores y Plumillas			
Forma	Nombre	Tamaño	N ^{ro} de partes	Tipo	N ^{ro} de partes	Color	N ^{ro} de partes
	DTP, EV4, PR4-10, PR4, PW4, SK4, SL4, THP, THV.	4"	DIN 12		P222	Rojo	82-60-0017-06
					P226	Azul	82-60-0023-06

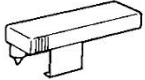
Modelo del Instrumento: Foxboro

Grafico				Marcadores y Plumillas			
Forma	Nombre	Tamaño	N ^{ro} de partes	Tipo	N ^{ro} de partes	Color	N ^{ro} de partes
	30, 40.	11-1/8"	FX 898074		L0121CJ	Roja	82-39-0202-06
			FX 898023		L0121CN	Negra	82-39-0101-06
			FX 898413		L0121CQ	Azul	82-39-0203-06
			FX 899413				



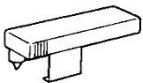

Modelo del Instrumento: Foxboro

Grafico				Marcadores y Plumillas			
Forma	Nombre	Tamaño	N ^{ro} de partes	Tipo	N ^{ro} de partes	Color	N ^{ro} de partes
	30, 40.	8-7/8"	FX 799413		CO149NP	Azul	82-60-0013-06
					CO149NS	Negra	82-60-0031-06
					CO149PW	Roja	82-60-0022-06

Modelo del Instrumento: Honeywell

Grafico				Marcadores y Plumillas			
Forma	Nombre	Tamaño	N ^{ro} de partes	Tipo	N ^{ro} de partes	Color	N ^{ro} de partes
	AR-100, DR 4200 GP/EV	10 – 5/16"	BN 24001660-001			Negro	82-39-0101-06
						Rojo	82-39-0202-06
						Azul	82-39-0303-06

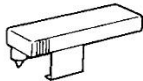
Modelo del Instrumento: Honeywell

Grafico				Marcadores y Plumillas			
Forma	Nombre	Tamaño	N ^{ro} de partes	Tipo	N ^{ro} de partes	Color	N ^{ro} de partes
	DR 4500 TRULINE	11 -7/8"	BN 30755317	Papel Térmico No requiere plumilla.			
	DR 4500 CLASSIC; SERVOLINE 1, 2, 3, 4.	11 -7/8"	BN 12001 BN 680060-48			Negro	82-39-0101-06
						Rojo	82-39-0202-06
						Azul	82-39-0303-06
						Verde	82-39-0404-06
	Modelo 111	6 - 7/16"	BN 10-56			Negro	82-39-0101-06
						Rojo	82-39-0202-06
						Azul	82-39-0303-06
						Verde	82-39-0404-06

Modelo del Instrumento: Masoneilan

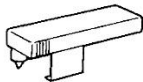
Grafico				Marcadores y Plumillas			
Forma	Nombre	Tamaño	N ^{ro} de partes	Tipo	N ^{ro} de partes	Color	N ^{ro} de partes
	Para todos sus registradores circulares	11 -1/8"	MAN 61004-1			Roja	82-39-0202-06
						Azul	82-39-0303-06
						Negra	82-39-0101-06

Modelo del Instrumento: Rockwell

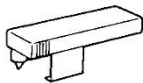
Grafico				Marcadores y Plumillas			
Forma	Nombre	Tamaño	N ^{ro} de partes	Tipo	N ^{ro} de partes	Color	N ^{ro} de partes
	CRG, TEMCORECTORS, 205.	9 -15/16"	PH 205-00-128-04 PH 209-40-128-17				82-39-0101-06
							82-39-0202-06

Modelo del Instrumento: Weksler

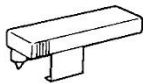
Grafico				Marcadores y Plumillas				
Forma	Nombre	Tamaño	N ^{ro} de partes	Tipo	N ^{ro} de partes	Color	N ^{ro} de partes	
	6", 8"	6", 8"	WR W120-30-6				0,14"	
							Negra	82-39-0101-06
							Roja	82-39-0102-06
							Azul	82-39-0103-06
							Verde	82-39-0104-06
							Púrpura	82-39-0106-06
							0,37"	
							Negra	82-39-0201-06
							Roja	82-39-0202-06
							Azul	82-39-0203-06
							Verde	82-39-0204-06
							Púrpura	82-39-0206-06

Modelo del Instrumento: Weksler

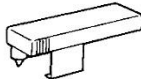
Grafico				Marcadores y Plumillas			
Forma	Nombre	Tamaño	N ^{ro} de partes	Tipo	N ^{ro} de partes	Color	N ^{ro} de partes
	6", 8"	6", 8"	WR W120-30-6			0,60"	
						Negra	82-39-0301-06
						Roja	82-39-0302-06
						Azul	82-39-0303-06
						Verde	82-39-0304-06
						Púrpura	82-39-0306-06
						0,83"	
						Negra	82-39-0401-06
						Roja	82-39-0402-06
						Azul	82-39-0403-06
						Verde	82-39-0404-06
						Púrpura	82-39-0406-06

UNIVERSAL SERIE 39

Plumilla Disponible para todos los gráficos circulares. Packaging/paquete: Six per package/6 piezas x paquete

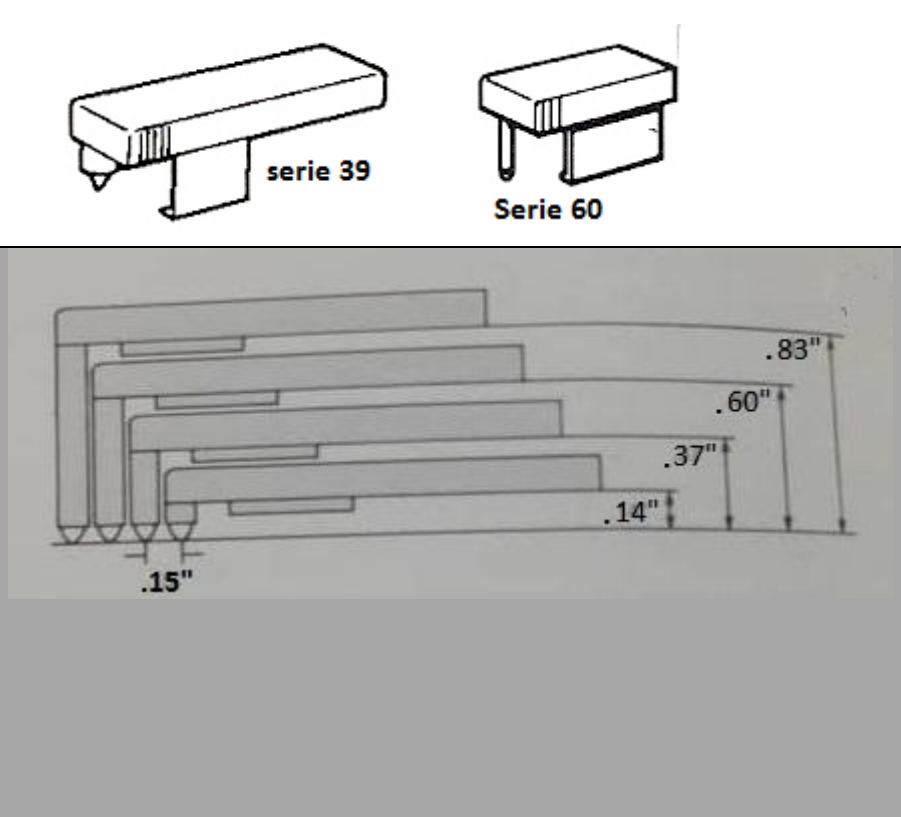
Nib LENGTH (Tamaño de la punta)	Color	Order by GC Part Number (Numero de Parte)	La Plumilla y tamaño de sus puntas
.14"	Black/Blanco	82-39-0101-06	
.14"	Red/Rojo	82-39-0102-06	
.14"	Blue/Azul	82-39-0103-06	
.14"	Green/Verde	82-39-0104-06	
.14"	Purple/Violeta/Purpura	82-39-0106-06	
.37"	Black/Blanco	82-39-0201-06	
.37"	Red/Rojo	82-39-0202-06	
.37"	Blue/Azul	82-39-0203-06	
.37"	Green/Verde	82-39-0204-06	
.37"	Purple/Violeta/Purpura	82-39-0206-06	
.60"	Black/Blanco	82-39-0301-06	
.60"	Red/Rojo	82-39-0302-06	
.60"	Blue/Azul	82-39-0303-06	
.60"	Green/Verde	82-39-0304-06	
.60"	Purple/Violeta/Purpura	82-39-0306-06	
.83"	Black/Blanco	82-39-0401-06	
.83"	Red/Rojo	82-39-0402-06	
.83"	Blue/Azul	82-39-0403-06	
.83"	Green/Verde	82-39-0404-06	
.83"	Purple/Violeta/Purpura	82-39-0406-06	



Calle la Pedrera, Centro Comercial
CEM II, Local Galpon #06, Terrazas
de Castillito,
San Diego, Edo. Carabobo.
Venezuela.
Pag Web:
<http://rosariograficos.com.ve>
Rif: J30082281-8 SAP: 100019396
PYMI - PEPS